

order number: L00000A0289

Patch cable U/UTP Cat.6, 1,0 m green RAL 6024, LSZH

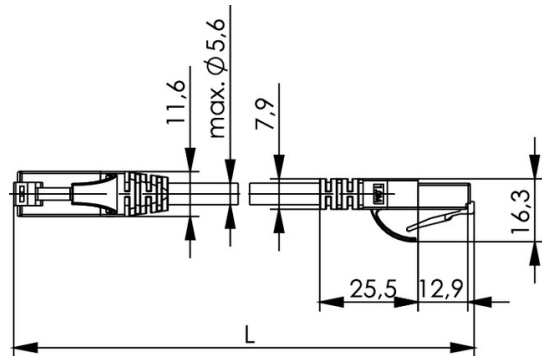

Fig. may differ



Technical Attributes	
Short name	MP8 250-1,0
Length	1 m
Colour	green

Performance Characteristics

- pin assignment acc. to EIA/TIA 568B
- pin assignment acc. to EIA/TIA 568B
- 360 degrees completely surround plug shielding (shielded cable types)
- 360 degrees completely surround plug shielding (shielded cable types)

Mechanical Characteristics	
Cable structure	Li2YH 4x2xAWG 24/7
Jacket diameter	5.4 mm (±0.2 mm)
Life (mating cycles RJ45, RJ12, RJ11)	≥ 750
Stranded wire	AWG 24 (7/0.2 mm)
Insulation	PE; Ø 1.0 mm (±0.05 mm)
Overall shielding	-

Climatic Characteristics	
UL	E244889
flame-retardant test	IEC 60332-1
Operating temperature in °C	-20° C to 75° C

Electrical Characteristics	
PoE+ acc to IEEE 802.3at	Adequate for Power over Ethernet+
Current carrying capacity at 50°C	1 A

Standards	
Connectors	IEC 60603-7-41

Gigabit Ethernet acc. to IEEE 802.3	Adequate for Gigabit Ethernet
10 Gigabit Ethernet acc. to IEEE 802.3an	Adequate for 10 Gigabit Ethernet